

Confirm that the delivered product is what you have ordered. Read this instruction sheet to make sure of correct operation. Make sure that the instruction sheet is kept by the end user.

This manual is the instruction sheet of the SmartAXIS Series FT1A Touch.  
Unless otherwise specified, SmartAXIS refers to the SmartAXIS Series FT1A Touch.

Touch	The generic term for the SmartAXIS FT1A-*12RA-*, FT1A-*14KA-* and FT1A-*14SA-*.
-------	---

## SAFETY PRECAUTIONS

- Be certain to read this manual carefully before performing installation, wiring, or maintenance work, or operating the Touch.
- This product has been manufactured with careful regard to quality. However, if you intend to use this product in applications where failure of this equipment may result in damage to property or injury, ensure that it used in conjunction with appropriate fail-safe backup equipment.
- In this manual, safety precautions are categorized in order of importance to Warning and Caution:

### **WARNING**

Warning notices are used to emphasize that improper operation may cause severe personal injury or death.

### **CAUTION**

Caution notices are used where inattention might cause personal injury or damage to equipment.

### **WARNING**

- The Touch is not intended to be used for applications which require high reliability and safety, such as medical equipment, nuclear equipment, railways, aircraft, and vehicles. The Touch cannot be used for these applications.
- For other applications which require high reliability in function and precision, provide a failsafe design and redundant design for the entire system including the Touch.
  - Emergency and interlocking circuits must be configured outside of the Touch.
  - If relays in the Touch output circuits should fail, outputs may remain at on or off state. For output signals which may cause serious accidents, configure monitor circuits outside the Touch.
  - The Touch self-diagnostic function may detect internal circuit or program errors, stop programs, and turn outputs off. Configure circuits so that the system containing the Touch are not jeopardized when outputs turn off.

- Emergency and interlocking circuits must be configured outside of the Touch.  
Do not use the Touch's internal touch switches for an emergency circuit. If the Touch failed, the external equipment connected to the Touch will no longer be protected and serious injury to operators and equipment damage may be caused.
- Turn off the power to the Touch before installation, removal, wiring, maintenance, and inspection of the Touch. Failure to turn power off may cause electrical shock or fire hazard.
- Special expertise is required to install, wire, configure, and operate the Touch. People without such expertise must not use the Touch.
- The Touch uses an LCD (liquid crystal display) as a display device. The liquid inside the LCD is harmful to the skin. If the LCD is broken and the liquid attaches to your skin or clothes, wash the liquid off using soap, and consult a doctor immediately.

### **CAUTION**

- Prevent the Touch from falling while moving or transporting, otherwise damage or malfunction of the Touch will result.
- Use the product within the environmental limits given in the catalog and manual. Use of the product in high-temperature or high-humidity environments, or in locations where it is exposed to condensation, corrosive gas or large shock loads can create the risk of electrocution and fire.
- The Touch is designed for use in pollution degree 2. Use the Touch in environments of pollution degree 2. (based on the IEC60664-1 rating)
- Install the Touch according to the instructions in the User's Manual. Improper installation will result in falling, failure, electrical shock, fire hazard, or malfunction of the Touch.
- Prevent metal fragments or wire chips from dropping inside the Touch housing. Ingress of such fragments and chips may cause fire hazard, damage, and malfunction.
- Use a power supply of the rated value. Using a wrong power supply may cause fire hazard.
- The Touch uses "PS2 of EN61131" as DC power supply. (based on the IEC/EN61131 rating)
- Use wire of a proper size to meet the voltage and current requirements.
- When exporting the Touch to Europe, use an EN60127 (IEC60127) approved fuse on the power line outside the Touch.
- When exporting the Touch to Europe, use an EU-approved circuit protector.
- Make sure of safety before starting and stopping the Touch. Incorrect operation of the Touch may cause mechanical damage or accidents.

- Use the Touch in a local area network if you download, upload or monitor the project data via the Ethernet port.
- The touch panel of the Touch is made of glass, and will break if exposed to excessive shock. Take due care when handling it.
- When more than one button is pressed at the same time, due to the detection characteristics of an analog type touch panel, only the gravity center of the pressed area is sensed and the unit assumes that only one button is pressed. Thus, when more than one button is pressed simultaneously, the resulting operation is not guaranteed.
- The screen becomes blank when the backlight is burnt out; however, the touch panel remains enabled. Incorrect touch panel operation will occur when operating the touch panel when the backlight appears to be turned off but is actually burnt out. Note that this erroneous operation may result in damage.
- Do not push hard or scratch the touch panel and protection sheet with a hard object such as a tool, because they are damaged easily.
- At temperatures over the rated operating temperature, the clock accuracy is affected. Adjust the clock before use.
- For applications which require clock accuracy, adjust the clock periodically.
- Do not install the Touch in areas subjected to strong ultraviolet rays, since ultraviolet rays may impair the quality of the LCD.
- Do not attempt to disassemble, repair or modify the Touch. This can create the risk of fire or electrocution.
- When disposing of the Touch, do so as an industrial waste.
- Do not switch off the power or pull out the USB Flash Drive while it is being accessed, as this may result in destruction of the stored data. If the data on the USB Flash Drive is corrupted, format the USB Flash Drive.

## Handling of Batteries and Devices with Built-in Batteries in EU Member States

Note) The following symbol mark is for EU countries only and is according to the directive 2006/66/EC Article 20 information for end-users and Annex II.



This symbol mark means that batteries and accumulators, at their end-of life, should be disposed of separately from your household waste.

If a chemical symbol is printed beneath the symbol shown above, this chemical symbol means that the battery or accumulator contains a heavy metal at a certain concentration. This will be indicated as follows :

Hg : mercury (0.0005%), Cd : cadmium (0.002%), Pb : lead (0.004%)

In the European Union there are separate collection systems for used batteries and accumulators.







Please dispose of batteries and accumulators correctly in accordance with each country or local regulation.

## Contents

1	Packing .....	6
2	Type Number .....	7
3	Part Names .....	8
4	External Interfaces .....	10
	4.1 Serial Interface (Port) .....	10
	4.2 I/O Terminals .....	11
	4.3 Input Terminal Specifications .....	13
	4.4 Output Specifications .....	17
5	Specifications .....	20
6	Dimensions .....	23
7	Installation .....	25
	7.1 Operating Environment .....	25
	7.2 Ambient Temperature .....	25
	7.3 Installation .....	27
	7.4 Orientation .....	28
	7.5 Attaching Cartridges .....	29
8	Wiring .....	30
	8.1 Power Supply Terminal .....	30
	8.2 Cautions when connecting external devices .....	31
	8.3 Cautions for using the Touch connected to a personal computer .....	31
9	USB Cable Lock Pin Attachment .....	32
10	Maintenance and Inspection .....	34
	10.1 Maintenance Screen .....	35
	10.2 System Mode .....	35
	10.3 Adjusting the Brightness and Contrast .....	36
	10.4 Adjusting the Touch Panel .....	37

## 1 Packing

Before installing the Touch, make sure that the specifications of the product conform to your requirements, and that no parts are missing or damaged due to accidents during transportation.

Name	Pcs/pack	
Touch Unit	1	
Instruction Sheet [This manual]	1	
Mounting clips	2	
Power plug (Attached to the Touch)	1	
Communication I/F plug (Attached to the Touch)	1	
USB Cable Lock Pin	2	
USB Clamp Band	2	

## 2 Type Number

LCD size	I/O configuration	Bezel color	Type No.
3.7inch STN Monochrome LCD	Digital sink in : 6pt Shared digital sink in / Analog in : 2pt Relay out : 4pt	Light gray	FT1A-M12RA-W
		Dark gray	FT1A-M12RA-B
		Silver	FT1A-M12RA-S
	Digital source in : 6pt Shared digital sink in / Analog in : 2pt Transistor sink out : 4pt Analog out : 2pt	Light gray	FT1A-M14KA-W
		Dark gray	FT1A-M14KA-B
		Silver	FT1A-M14KA-S
	Digital sink in : 6pt Shared digital sink in / Analog in : 2pt Transistor source out : 4pt Analog out : 2pt	Light gray	FT1A-M14SA-W
		Dark gray	FT1A-M14SA-B
		Silver	FT1A-M14SA-S
3.8inch TFT Color LCD	Digital sink in : 6pt Shared digital sink in / Analog in : 2pt Relay out : 4pt	Light gray	FT1A-C12RA-W
		Dark gray	FT1A-C12RA-B
		Silver	FT1A-C12RA-S
	Digital source in : 6pt Shared digital sink in / Analog in : 2pt Transistor sink out : 4pt Analog out : 2pt	Light gray	FT1A-C14KA-W
		Dark gray	FT1A-C14KA-B
		Silver	FT1A-C14KA-S
	Digital sink in : 6pt Shared digital sink in / Analog in : 2pt Transistor source out : 4pt Analog out : 2pt	Light gray	FT1A-C14SA-W
		Dark gray	FT1A-C14SA-B
		Silver	FT1A-C14SA-S

### 3 Part Names

#### ■ FT1A-12RA

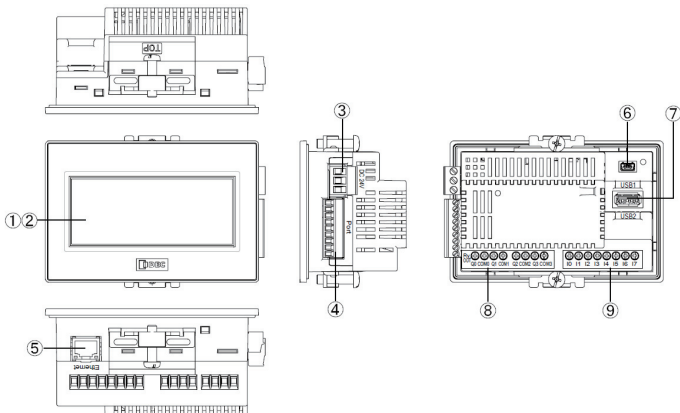

No.	Name	Description
(1)	Display	
(2)	Touch Panel	
(3)	Power Supply Terminal	
(4)	Serial Interface (Port)	RS232C, RS422/485 Connector : Terminal Block 9 pin
(5)	Ethernet Interface (Ethernet)	IEEE802.3u 10BASE-T/100BASE-TX Connector : RJ-45
(6)	USB Interface (USB1)	USB2.0 (Device) Connector : Mini-B
(7)	USB Interface (USB2)	USB1.1 (External device) Connector: TypeA
(8)	Output Terminal (Q0 to Q3)	Relay output (10A)
(9)	Input Terminal (I0 to I7)	Digital input, Analog input



■ FT1A-\*14KA/14SA

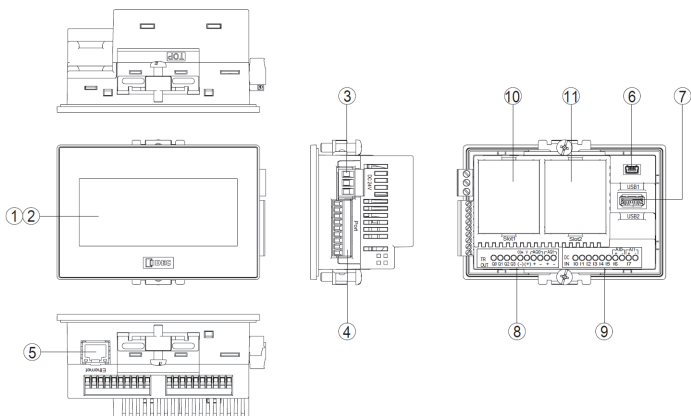

No.	Name	Description
(1)	Display	
(2)	Touch Panel	
(3)	Power Supply Terminal	
(4)	Serial Interface (Port)	RS232C, RS422/485 Connector : Terminal Block 9 pin
(5)	Ethernet Interface (Ethernet)	IEEE802.3u 10BASE-T/100BASE-TX Connector : RJ-45
(6)	USB Interface (USB1)	USB2.0 (Device) Connector : Mini-B
(7)	USB Interface (USB2)	USB1.1 (External device) Connector : Type A
(8)	Output Terminal (Q0 to Q3, AQ0 to AQ1)	Transistor output, analog output
(9)	Input Terminal (I0 to I7)	Digital input, Analog input
(10)	Slot 1	Optional product (analog cartridge) expansion FC6A-PJ2A FC6A-PK2AV FC6A-PK2AW FC6A-PJ2CP
(11)	Slot 2	Optional product (analog cartridge) expansion FC6A-PJ2A FC6A-PK2AV FC6A-PK2AW FC6A-PJ2CP

## 4 External Interfaces

### CAUTION

- Make sure to turn off the power to the Touch before wiring each interface.
- Always use ferrules when wiring stranded wire and multiple wires to the terminal block. Otherwise there is a risk of wires becoming disconnected.

#### 4.1 Serial Interface (Port)

Interface Specification	RS232C, RS422/485
Connector	Detachable Terminal Block 9 pin
Applicable cable	RS232C: AWG16 to AWG28 RS422/485: AWG16 to AWG28 Shielded twisted-pair Stripped wire length 7 mm (Solid wire)
Recommended ferrule	AI 0.34-8 TQ (For AWG22) AI 0.5-8 WH (For AWG20) AI 0.75-8 GY (For AWG18) AI 1-8 RD (For AWG18) AI 1.5-8 BK (For AWG16) (Phoenix Contact)
Tightening Torque	0.25 N·m



No.	Name	I/O	Function	Communication type	
1	SD	OUT	Send Data	RS232C	
2	RD	IN	Receive Data		
3	RS	OUT	Request to Send		
4	CS	IN	Clear to Send		
5	SG	-	Signal Ground		
6	SDA	OUT	Send Data (+)		RS422/485
7	SDB	OUT	Send Data (-)		
8	RDA	IN	Receive Data (+)		
9	RDB	IN	Receive Data (-)		

<Note>

The Touch is not equipped with terminating resistance. When using the RS422/485 interface, insert terminating resistance with the appropriate value (around 100 to 120 Ω) between terminal No. 8 (RDA) and terminal No. 9 (RDB) as required.

## 4.2 I/O Terminals

### ■ FT1A-\*12RA

Applicable cable	AWG16 to AWG22 Stripped wire length 6.5 mm, coating diameter $\phi$ 3.4 mm or lower (Solid wire)
Recommended ferrule	AI 0.34-8 TQ (For AWG22, For 1 wire) AI 0.5-8 WH (For AWG20, For 1 wire) AI 0.75-8 GY (For AWG18, For 1 wire) AI 1-10 RD (For AWG18, For 1 wire) AI 1.5-10 BK (For AWG16, For 1 wire) AI TWIN 2 x 0.75 10GY (For AWG18, For 2 wires) (Phoenix Contact)
Tightening Torque	0.5 to 0.6 N•m (Screwdriver SZS 0.6 x 3.5, Phoenix Contact)

### ■ FT1A-\*14KA/14SA

Applicable cable	AWG20 to AWG22 Stripped wire length 5 mm, coating diameter $\phi$ 2.6 mm or lower (Solid wire)
Recommended ferrule	AI 0.34-8 TQ (For AWG22, For 1 wire) AI 0.5-8 WH (For AWG20, For 1 wire) AI-TWIN2 x 0.5-8 WH (For AWG20, For 2 wires) (Phoenix Contact)
Tightening Torque	0.2 N•m (Screwdriver SZS 0.4 x 2.5, Phoenix Contact)

## ● Terminal Arrangement

### • Terminal Arrangement and I/O Wiring Diagrams

### ■ FT1A-\*12RA

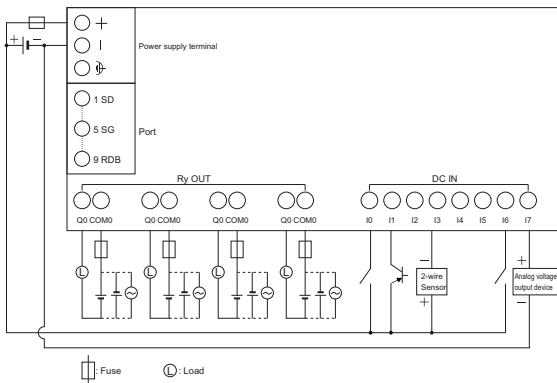

## ■ FT1A-\*14KA

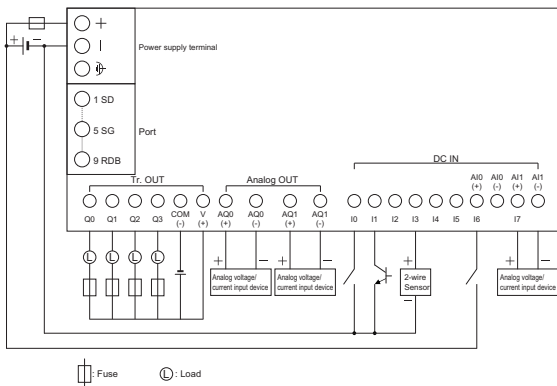

## ■ FT1A-\*14SA

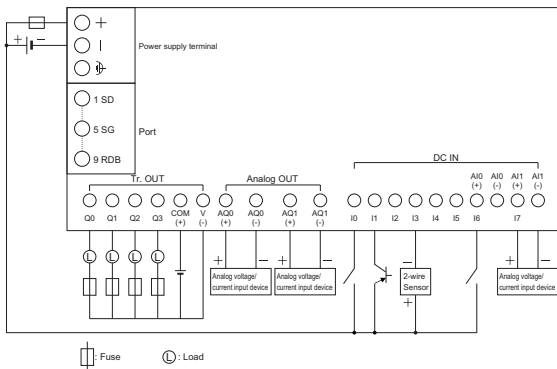

### 4.3 Input Terminal Specifications

Input Points	8
Rated Input Voltage	24V DC
Input Voltage Range	0 to 28.8V DC
Effect of Improper Input Connection	No damage. (If any input exceeding the rated value is applied, permanent damage may be caused.)

#### ● Digital Input Specifications

Input Type	Sink (FT1A-*12RA/14SA) Source (FT1A-*14KA)	
Input Points (Terminal No. /Common Line Name)	6 points in 1 common line (I0 to I5/Power supply "-" terminal)	
Rated Input Current	4.4mA (Sink Input) 5.2mA (Source Input)	
Input Impedance	5.5k $\Omega$ (Sink Input) 4.7k $\Omega$ (Source Input)	
Input System Transfer Time	OFF $\rightarrow$ ON	2.5 $\mu$ s + filter value
	ON $\rightarrow$ OFF	5 $\mu$ s + filter value
Isolation	Between input terminals	Not isolated
	Internal circuit	Not isolated
Input Type	Type1 (IEC61131-2)	
External Load for I/O Interconnection	Not needed	
Signal Determination Method	Static	
Cable Length (in compliance with EMC standards)	3m	

#### ● Analog Input Specifications

##### ■ FT1A-\*12RA

Input Signal Type	Voltage Input
Input Points (Terminal No. /Common Line Name)	2 points in 1 common line (I6, I7/internal -terminal, SG terminal for Port)
Input Range	0 to 10V DC
Input Impedance	78.0K $\Omega$
Digital Resolution	0 to 1,000 (10bit)
Data Type	Binary data: 0 to 1000
Input Value of LSB	10mV
Type of Input	Single-ended input

AD Conversion	Sample Duration Time	2 msec max.
	Sample Repetition Time	2 msec max.
	Total Input System Transfer Time	3 msec + filtering time + scan time
Input Error	Maximum Error at 25°C	±3.0% of full scale
	Temperature Coefficient	±0.04% of full scale/°C
	Maximum Error	±5.0% of full scale
General Characteristics	Operating Mode	Self-scan
	Conversion Method	$\Sigma\Delta$ type
Status Display		Device Monitor screen (LCD)
Maximum Temporary Error during Electrical Noise Tests		±5.0% of full scale
Recommended Cable for Noise Immunity		Twisted pair shielded cable
Calibration or Verification to Maintain Rated Accuracy		Not possible
Maximum Permanent Allowed Overload (No Damage)		28.8V DC
Overload Status (Outside Input Range) Detection		Detectable
Isolation	Between input terminals	Not isolated
	Between input and internal circuit	Not isolated
Used as Digital Input	Digital Input Type	— (IEC 61131-2 digital input type is not supported)
	Input Threshold	ON voltage: 15V min. (ON current: 0.20 mA min.) OFF voltage: 5V max. (OFF current: 0.06 mA max.)

#### ■ FT1A-\*14KA/14SA

Input Signal Type	Voltage/current input (selectable with software)
Input Points (Terminal No. /Common Line Name)	1 point in 1 common line AI0+, AI1+ / AI0-, AI1-
Input Range	0 to 10V DC (Voltage Input) 4 to 20mA (Current Input)
Input Impedance	78.0K $\Omega$ (Voltage Input) 250 $\Omega$ (Current Input)
Digital Resolution	0 to 1,000 (10bit)
Data Type	Binary data: 0 to 1000
Input Value of LSB	10mV (Voltage Input) 16 $\mu$ A (Current Input)
Type of Input	Single-ended input

AD Conversion	Sample Duration Time	2 msec max.
	Sample Repetition Time	2 msec max.
	Total Input System Transfer Time	3 msec + filtering time + scan time (Voltage Input) 12 msec + filtering time + scan time (Current Input)
Input Error	Maximum Error at 25°C	±3.0% of full scale
	Temperature Coefficient	±0.04%/°C of full scale
	Maximum Error	±5.0% of full scale
General Characteristics	Operating Mode	Self-scan
	Conversion Method	SAR
Status Display	Device Monitor screen (LCD)	
Maximum Temporary Error during Electrical Noise Tests	±5.0% of full scale	
Recommended Cable for Noise Immunity	Twisted pair shielded cable	
Calibration or Verification to Maintain Rated Accuracy	Not possible	
Maximum Permanent Allowed Overload (No Damage)	28.8V DC (Voltage Input) 40mA (Current Input)	
Overload Status (Outside Input Range) Detection	Detectable	
Isolation	Between input terminals	Not isolated
	Between input and internal circuit	Not isolated
Used as Digital Input	Digital Input Type	— (IEC 61131-2 digital input type is not supported)
	Input Threshold	ON voltage: 15V min. (ON current: 0.20 mA min.)
OFF voltage: 5V max. (OFF current: 0.06 mA max.)		

## ● Equivalent Circuit

### ■ FT1A-\*12RA

#### Sink Input (I0 to I5)

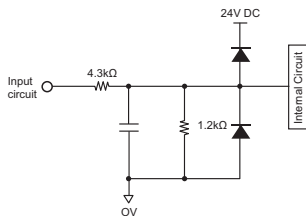

#### Shared Digital/Analog Input (I6, I7)

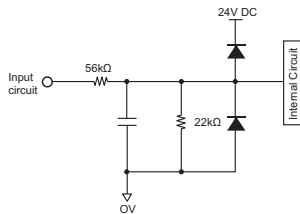

## ■ FT1A-\*14KA

Source Input (I0 to I5)

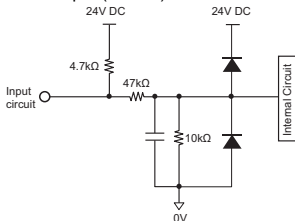

Shared Digital/Analog Input (I6, I7)

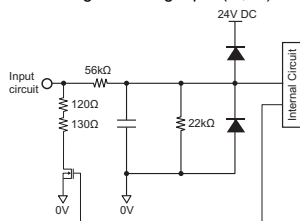

## ■ FT1A-\*14SA

Sink Input (I0 to I5)

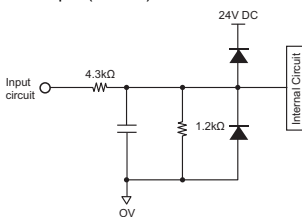

Shared Digital/Analog Input (I6, I7)

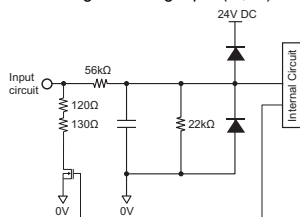

## ● Operating Range

Sink Input (I0 to I5)

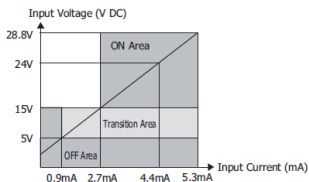

Source Input

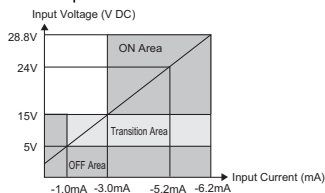

Shared Digital/Analog Input (I6, I7)

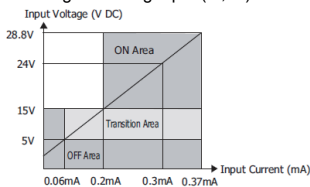



## 4.4 Output Specifications

### ● Relay Output Specifications

#### ■ FT1A-\*12RA

No. of Outputs (Terminal No.)		4 (Q0 to Q3)
Output Type		1a contact
Maximum Load Current		10A
Minimum Switching Load		10 mA/5V DC (reference value)
Initial Contact Resistance		100 mΩ max. (1A, 6V DC)
Electrical Life		100,000 operations min. (rated load 1,800 operations/hour)
Mechanical Life		20,000,000 operations min. (no load 18,000 operations/hour)
Rated Load		250V AC/10A, 30V DC/10A
Dielectric Strength	Between output terminal and internal circuit	2,300V AC 5mA, 1 minute
	Between output terminals (COMs)	
Status Display		Device Monitor screen (LCD display)

### Output Delay

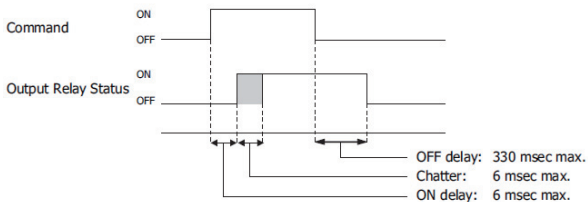

● Transistor Output Specifications

■ FT1A-\*14KA/14SA

No. of Outputs (Terminal No.)	4 (Q0 to Q3)
Output Type	Sink output (FT1A-*14KA) Source output (FT1A-*14SA)
Rated Load	24V DC
Operating Load Voltage Range	20.4 to 28.8V DC
Maximum Load Current	0.3A
Voltage Drop (ON voltage)	1V max. (Voltage between COM and output terminal when ON)
Maximum Inrush Current	1A
Leakage Current	0.1 mA max.
Clamping Voltage	39V ±1V
Maximum Lamp Load	8W
Inductive Load	L/R=10 ms (28.8V DC, 1 Hz)
External Current Draw	100 mA max., 24V DC Sink output: power voltage at the +V terminal Source output: power voltage at the +COM terminal
Isolation	Photocoupler isolated
Status Display	Device Monitor screen (LCD display)

● Equivalent Circuit

■ FT1A-\*14KA/14SA

Sink Output (Q0 to Q3)

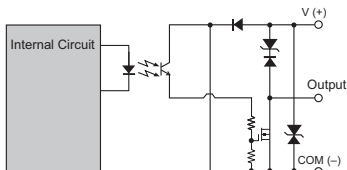

Source Output (Q0 to Q3)

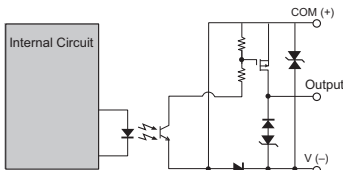

● Analog Output Specifications

■ FT1A-\*14KA/14SA

No. of Outputs (Terminal No.)		2 (AQ0 to AQ1)
Output Type		Voltage/current output
Output Range		0 to 10 V (Voltage output) 4 to 20 mA (Current output)
Output Load	Impedance	2 k $\Omega$ min. (Voltage output) 500 $\Omega$ max. (Current output)
	Load Type	Resistance load
D/A Conversion	Scan Time	1 scan
	Settling Time	1 msec or lower
	Total Output System Transfer Time	1 msec + 1 scan
Digital Resolution		0 to 1,000 (10bit)
Output Value of LSB		10 mV (Voltage output) 16 $\mu$ A (Current output)
Data Type		Binary data: 0 to 1000
Monotonicity		Yes
Output Error	Maximum Error at 25°C	$\pm 0.3\%$ of full scale
	Temperature Coefficient	$\pm 0.02\%/^{\circ}\text{C}$ of full Scale
	Reproducibility After Stabilization Time	$\pm 0.4\%$ of full scale
	Non-linearity	$\pm 0.01\%$ of full scale
	Output Ripple	30 mV max.
	Overshoot	0% *1
	Maximum Error	$\pm 1.0\%$ of full scale
Open Current Loop		Cannot be detected

\*1. Overshoot may occur at light loads.

The occurrence of overshoot can be controlled by inserting damping resistance into the circuit. A general guide for the damping resistance value is about 150  $\Omega$  including the input line impedance for the destination.

## 5 Specifications

### ● Applicable Standards

Safety Standard	UL508 CSA C22.2 No.142 (c-UL)
EMC Standard*1	IEC/EN 61131-2:2007

- \*1. When using the Touch as the EMC Standard Approved Products, attach a ferrite core (ZCAT3035-1330 manufactured by TDK Corporation) to the power cables and the communication cables. If there is a risk of an error occurring due to noise, install the product separated from sources of noise such as power lines, high voltage lines, and load lines. Also attach a ferrite core to the I/O cable (ZCAT3035-1330 manufactured by TDK Corporation).

### ● Environmental Specifications

Operating Temperature*2	0 to 55°C: FT1A-M (Monochrome LCD models) -20 to 55°C: FT1A-C (Color LCD models) (No freezing)
Relative	10 to 95% RH (No condensation)
Storage Temperature	-20 to +60°C (No freezing)
Storage Humidity	10 to 95% RH (No condensation)
Altitude	Operation: 0 to 2,000m Transport: 0 to 3,000m
Pollution Degree	2
Corrosion Immunity	Free from corrosive gases

- \*2. The UL and c-UL certified operating temperature of the FT1A-\*12RA-\* is 0 to 50°C.

### ● Electrical Specifications

#### ■ FT1A-\*12RA

Rated Voltage	24V DC
Power Consumption	9.2W max. When USB2 is unused: 5.8W max.
Power Voltage Range	20.4 to 28.8V DC
Allowable Momentary Power Interruption	10 msec max.
Inrush Current	50A max.
Dielectric Strength	Between power and FE terminals: 500V AC, 5mA, 1 minute Between power and output terminals: 2,300V AC, 5mA, 1 minute

#### ■ FT1A-\*14KA/14SA

Rated Voltage	24V DC
Power Consumption	11.0W max. When USB2 is unused: 8.1W max.
Power Voltage Range	20.4 to 28.8V DC
Allowable Momentary Power Interruption	10 msec max.
Inrush Current	50A max.
Dielectric Strength	Between power and FE terminals: 500V AC, 5mA, 1 minute Between power and output terminals: 500V AC, 5mA, 1 minute

● Construction Specifications

Vibration Resistance	5 to 8.4Hz amplitude 3.5mm, 8.4 to 150Hz acceleration 9.8m/s <sup>2</sup> 10 times on each of three mutually perpendicular axes (100 minutes) (IEC61131-2)
Shock Resistance	147m/s <sup>2</sup> , 11ms (5 shocks on each of three mutually perpendicular axes) (IEC61131-2)

● Performance Specifications

Type Number	FT1A-M (Monochrome LCD models)	FT1A-C (Color LCD models)	
Display	LCD Type	STN Monochrome LCD	TFT Color LCD
	Display Colors	2 Colors (Black, White) 8 shades	65,536 Colors
	Effective Display Area [mm]	87.59(W) × 35.49 (H)	88.92 (W) × 37.05 (H)
	Display Resolution	240 (W) x 100 (H) pixels	
	View angle	Left/Right/Top/Bottom: 45°	Left/Right: 40°, Top: 20°, Bottom: 60°
	Contrast Adjustment	32 levels	–
	Brightness of LCD only	White: 740 [cd/m <sup>2</sup> ] Red: 135 [cd/m <sup>2</sup> ]	400 [cd/m <sup>2</sup> ]
	Brightness Adjustment	32 levels	
	Backlight	LED (White, Red) Screen color: White, Pink, Red	LED (White)
	Backlight Life*3	50,000 hours nominal	
Touch Panel	Switch Type	Analog Resistive Film	
	Operating Force	0.2 to 2.5 N	
	Multiple Operations	Impossible	
	Life	1,000,000 operations	
User Memory	5MB		
Backup Battery*4	Lithium secondary battery Backup Duration: Approx. 30 days (typical) (Operating temperature: 25°C) Charging Time: Approx. 15 hours for charging from 0% to 90% of full charge Battery Life: 5 years in cycles of 9-hour charging and 15-hour discharging Replaceability: Not possible to replace battery		
Backup Data	128KB		
Buzzer Output	Single tone (tone length is adjustable)		
Degree of Protection	IP66F (IEC60529) *5		

Weight (approx.)	FT1A-*12RA: 300 g FT1A-*14KA/SA: 250 g
------------------	---

- \*3. The backlight life refers to the time until the surface brightness reduces to a half after using continuously at room temperatures.
- \*4. In high temperature environments battery life may be affected, so retention time may be reduced.
- \*5. The degree of protection for the operating section after the panel is attached. The compliance test has been passed, but this is not a guarantee of operation in all environments.

#### ● EMC Specifications

Type Number	FT1A-*12RA	FT1A-*14KA/SA
Radiated Emission	Class A : 10m 40dB $\mu$ V/m quasi-peak (30M to 230MHz) 47dB $\mu$ V/m quasi-peak (230M to 1GHz)	
Electrostatic Discharge	Contact : $\pm$ 6kV Air : $\pm$ 8kV	
Electromagnetic Field	10V/m (80 to 1000 MHz) 3V/m (1.4 to 2.0 GHz) 1V/m (2.0 to 2.7 GHz) 80% AM (1kHz)	
Fast Transient Burst	$\pm$ 2kV (Power, Output terminal) $\pm$ 1kV (Port, Ethernet, Input terminal)	$\pm$ 2kV (Power) $\pm$ 1kV (Port, Ethernet, Input terminal, Output terminal)
Surge Immunity	$\pm$ 500V (between +24V-0V) $\pm$ 1kV (between +24V-FE, 0V-FE)	
Conducted Radio Frequency Immunity	10V (Power, Port, Ethernet, Input terminal, Output terminal) (150kHz to 80MHz) 80% AM (1kHz)	

## 6 Dimensions

### ■ FT1A-\*12RA

Unit: mm

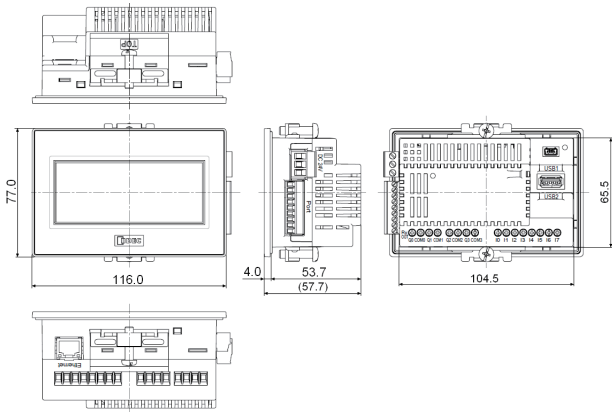

### <Cable Attached Dimensions>

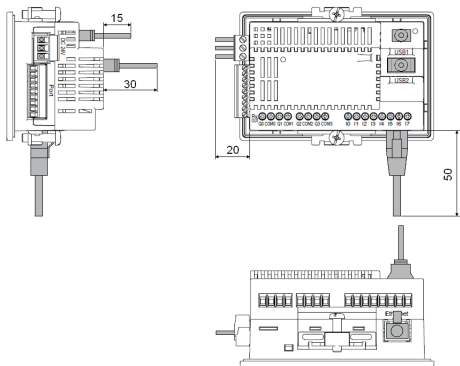

Depending on the type of connection cable used the dimensions shown above will change. The dimensions given here are intended for reference only.

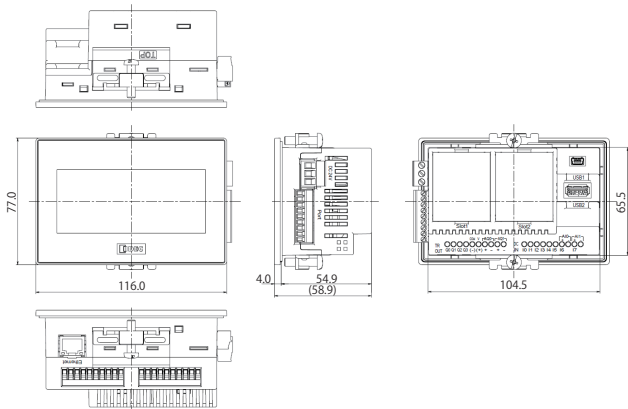

<Cable Attached Dimensions>

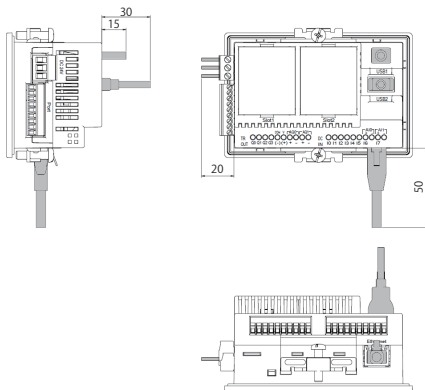

Depending on the type of connection cable used the dimensions shown above will change. The dimensions given here are intended for reference only.



## 7 Installation

### 7.1 Operating Environment

For designed performance and safety of the Touch, do not install the Touch in the following environments:

- Where dust, briny air, or iron particles exist.
- Where oil or chemical splashes for a long time.
- Where oil mist is filled.
- In direct sunlight.
- Where strong ultraviolet rays exist.
- Where corrosive or combustible gasses exist.
- Where the Touch is subjected to shocks or vibrations.
- Where condensation occurs due to rapid temperature change.
- Where high-voltage or arc-generating equipment (electromagnetic contactors or circuit protectors) exists in the vicinity.

### 7.2 Ambient Temperature

- Allow sufficient space for ventilation, and install the equipment away from heat sources.
- Allow at least 100mm between the Touch and walls or other equipment.
- Do not install the Touch where the ambient temperature exceeds the rated operating ambient temperature range. When mounting the Touch in such locations, provide a forced air-cooling fan or air-conditioner to keep the ambient temperature within the rated temperature range.
- The Touch is designed to install on a vertical plane so that natural air-cooling is provided. If you install it using any other orientation, use forced-air cooling, or lower the ambient operating temperature.

### Derating

#### ■ FT1A-\*12RA

When using the Touch at an ambient temperature of 45°C or higher, reduce the output current of each output terminal as shown in the figure below.

Installed upright in landscape orientation

Output Current

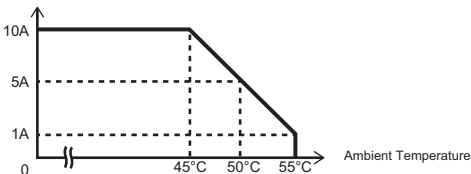

<Note>

If operating the Touch in a high-temperature environment, reducing the brightness of the backlight can help to limit the temperature rise of internal components.

The relationship between ambient temperature, the output current of each output terminal, and brightness is approximately as shown in the figure below.

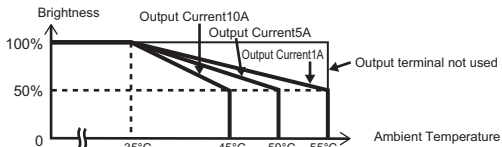

The values shown above may vary with individual products. Please use this information as a reference at the time of design.

■ FT1A-\*14KA/14SA

When used at ambient temperatures of 40°C or higher, limit the usage of analog current output and the analog cartridge as shown in the figure below.

Power Voltage Range	Touch Analog Output	Cartridge	Operating Temperature
20.4 to 24V DC	Voltage/current output cannot be used	Voltage output (FC6A-PK2AV)/ current output (FC6A-PK2AW) cannot be used	55°C
20.4 to 28.8V DC	Current output cannot be used	Voltage output (FC6A-PK2AV)/ current output (FC6A-PK2AW) cannot be used	50°C
20.4 to 28.8V DC	No restrictions	Voltage output (FC6A-PK2AV)/ current output (FC6A-PK2AW) cannot be used	45°C
20.4 to 28.8V DC	Current output cannot be used	Current output (FC6A-PK2AW) cannot be used	45°C
20.4 to 28.8V DC	No restrictions	No restrictions	40°C

<Note>

If operating the FT1A-\*14KA/14SA in a high-temperature environment, reducing the brightness of the backlight can help to limit the temperature rise of internal components.

The relationship between ambient temperature and brightness is approximately as shown in the figure below.

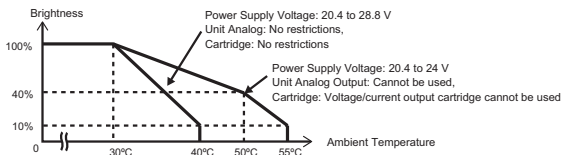

The values shown above may vary with individual products. Please use this information as a reference at the time of design.

## 7.3 Installation

- Make a panel cut-out on the panel with the dimensions shown below.

Unit: mm

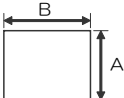

A		B		Panel Cut-out
66.0	+1.0 0	105.0	+1.0 0	1.0 to 5.0

- The Touch has the mounting clip positions not only on the top and bottom side (0.3 to 0.35 N·m).

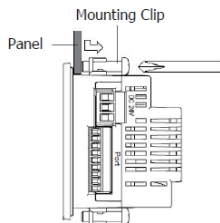
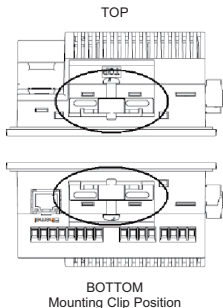



### CAUTION

- Do not tighten excessively, otherwise the Touch may warp and cause wrinkle on the display, or impair the waterproof characteristics.
- If the mounting clips are tightened obliquely to the panel, the Touch may fall off the panel.
- When installing the Touch into a panel cut-out, make sure that the gasket is not twisted. Especially when re-installing, take special care because any twists in the gasket will impair the waterproof characteristics.
- Even in the panel thickness range, there is a risk that the waterproof characteristics cannot be maintained due to the panel materials and size.

## 7.4 Orientation

The Touch is designed to install on a vertical landscape. If you install it with any other orientation, confirm the limitations about operating temperature.

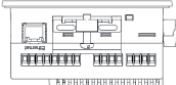
Orientation		Operating Temperature	
		FT1A-M (Monochrome LCD models)	FT1A-C (Color LCD models)
Vertical	Landscape 	0 to 55°C	-20 to 55°C (No freezing)
	Portrait (Clockwise) 	0 to 50°C	-20 to 50°C (No freezing)
	Portrait (Counter Clockwise) 	0 to 55°C	-20 to 55°C (No freezing)
Horizontal 		0 to 50°C	-20 to 50°C (No freezing)

<Note>

- When installing the Touch in a diagonal, the limitations are same as a horizontal.
- Confirm the visibility of the display in a final installation.

## 7.5 Attaching Cartridges

Step 1 Insert two flat head screwdrivers into the screwdriver insertion slots in both locations of the unit, and while pushing the tabs of the cartridge cover, pull the cartridge cover directly upward to remove it.

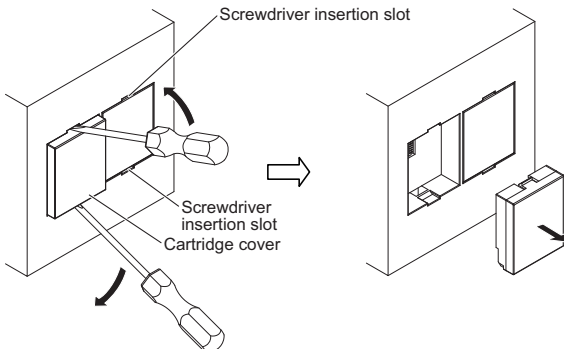

Step 2 Pay careful attention to the direction of the cartridge and attach it directly onto the unit.

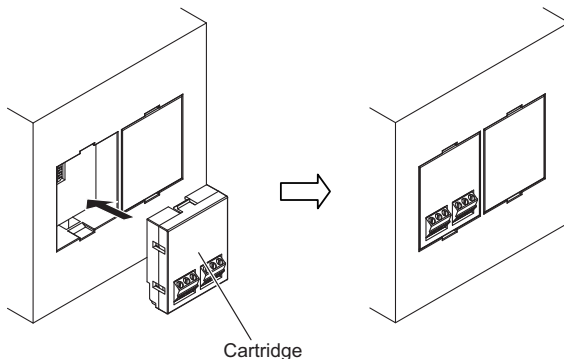

To remove the cartridge, perform the work detailed in step 1.

### CAUTION

- Attach the cartridge directly onto the unit. If the cartridge is attached when tilted, it may be damaged or cause operating problems.
- Always use ferrules when wiring stranded wire and multiple wires to the terminal block. Otherwise there is a risk of wires becoming disconnected.

### ⚠ CAUTION

- Turn off the power supply before wiring.
- Make the wiring as short as possible and run all wires as far away as possible from high-voltage and large-current cables. Follow all the procedures and precautions when wiring the Touch.
- Separate the Touch power supply wiring from the power lines of I/O devices and motor equipment.
- Ground the functional earth terminal to make sure of correct operation.
- Always use ferrules when wiring stranded wire and multiple wires to the terminal block. Otherwise there is a risk of wires becoming disconnected.

### 8.1 Power Supply Terminal

- Pin assignment is shown in the following table.



+	Power supply 24V DC (+24V)
-	Power supply 0V (0V)
⏏	Functional Earth (FE)

- Use applicable cables for wiring and recommended ferrules (made by Phoenix Contact) as follows.

Applicable cable	AWG16 to AWG22 Stripped wire length 7 mm (Solid wire)
Recommended ferrule	AI 0.34-8 TQ (For AWG22) AI 0.5-8 WH (For AWG20) AI 0.75-8 GY (For AWG18) AI 1-8 RD (For AWG18) AI 1.5-8 BK (For AWG16) AI-TWIN 2×0.5-8 WH (For AWG20, TWIN Pressure Terminal) AI-TWIN 2×0.75-8 GY (For AWG18, TWIN Pressure Terminal) (Phoenix Contact)
Tightening Torque	0.5 to 0.6 N·m

## 8.2 Cautions when connecting external devices

The Touch power supply is non-isolating. Interference or external noise from external devices due to wiring may cause adverse effects on the internal circuits of the Touch or external devices.

To prevent such damage, choose a proper solution depending on your system setup.

- Use a separate earth ground from the external noise source device.
- The wire for grounding should be thick and short in order to direct the noise from the noise source device to the earth ground.
- Use a separate power supply from the external noise source device.
- Insert an isolator on the communication line of the Touch and the non-isolated communication device (i.e. PLC) to prevent damage.

## 8.3 Cautions for using the Touch connected to a personal computer

When connecting the Touch to a computer via the Serial Interface (Port) or USB Interface, the Touch or the computer may break down depending on the conditions of the computer. Make sure of the following cautions, in order to prevent an accident.

- If the computer has a 3-pin power plug or power plug with a ground lead type.  
Make sure to use a plug socket including a ground input electrode or ground the earth lead, respectively.
- If the computer has a 2-pin power plug without ground lead, follow the procedure below when connect the Touch to the computer.
  - (1) Pull out the power plug of the computer from the AC outlet.
  - (2) Connect the Touch to the computer.
  - (3) Insert the power plug of the computer into the AC outlet.

## 9 USB Cable Lock Pin Attachment

When using the USB interface (USB1, USB2), attach the USB cable lock pin to prevent disconnecting the USB cable from the Touch.

- 1 Insert the USB cable into the USB port.
- 2 Strain the "Edge part" of the USB cable lock pin, and insert the "Edge part" to the 2 holes upper the USB port.

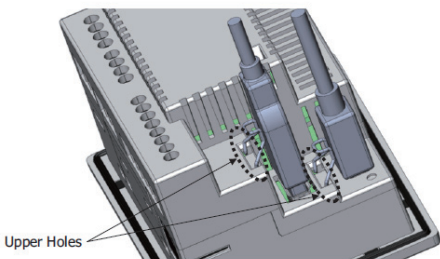

- 3 Fasten the USB clamp band around the USB cable and the clamp part, secure them tightly.

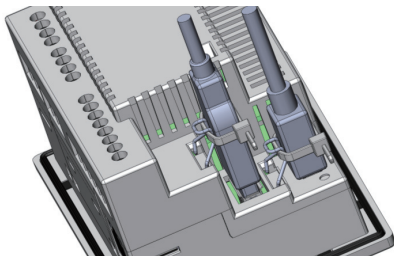



<Note>

Fasten the USB clamp band without the space between the clamp part and it, and the inclination.

OK

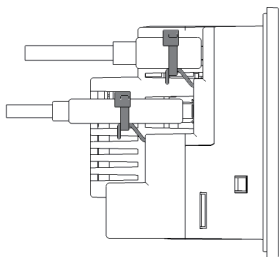

NG

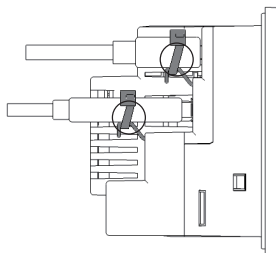
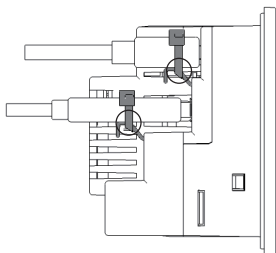

## 10 Maintenance and Inspection

Maintain and inspect the Touch periodically to ensure the best performance. Do not disassemble, repair, or modify the Touch during inspection.

Display	Wipe any stain of the display using a soft cloth slightly dampened with neutral detergent or alcoholic solvent. Do not use solvents such as thinner, ammonia, strong acid, and strong alkaline.
Terminals, Connectors	Check the terminals and connectors to make sure of no loose screws, incomplete insertion, or disconnected lines.
Mounting Clips	Make sure that all mounting clips and screws are tightened sufficiently. If the mounting clips are loose, tighten the screw to the recommended tightening torque.
Backlight	The Touch backlight cannot be replaced by the customer. When the backlight needs to be replaced, contact IDEC.
Touch Panel	A gap may be caused in the operation accuracy of the touch panel by the secular distortion, etc. Adjust the touch panel according to the following procedure when there is a gap in the operation of the touch panel.

## 10.1 Maintenance Screen

Turn on the power to the Touch, then press and hold the upper-left corner of the screen for three seconds or longer.

The Maintenance Screen appears on the screen.

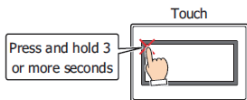

Maintenance Screen (Color LCD models)

Maintenance		X
System Mode	Device Monitor	
Brightness	Ladder Monitor	
Ladder Start/Stop		

Maintenance Screen (Monochrome LCD models)

Maintenance		X
System Mode	Device Monitor	
Brightness/ Contrast	Ladder Monitor	
Ladder Start/Stop		

- Permission to show the Maintenance Screen can be set using the configuration software. Refer to the User's Manual for details.
- The Maintenance Screen is not displayed in the System Mode.

## 10.2 System Mode

Press the **System Mode** at the top of the Maintenance Screen. The Top page Screen appears.

Top Page (Color LCD models)

SYSTEM MODE TOP PAGE		
Run	Main Menu	
2012/JUL/20/FRI 14:30:00		
IP Add. : 192.168.0.1 (DHCP)		
<<	BRIGHTNESS 31	>>

Top Page (Monochrome LCD models)

SYSTEM MODE TOP PAGE		
Run	Main Menu	
2012/JUL/20/FRI 14:30:00		
IP Add. : 192.168.0.1 (DHCP)		
<<	CONTRAST 31	>>
<<	BRIGHTNESS 31	>>

- Initial Setting, Self Diagnosis and Initialization of the data, etc can be executed in the System mode.

### 10.3 Adjusting the Brightness and Contrast

The brightness and contrast of the Touch display can be adjusted on the Adjust Brightness/Contrast Screen. Adjust the brightness and contrast to the best condition as required.

- 1 Press the **Brightness** (color LCD models) or **Brightness/Contrast** (monochrome LCD models) on the Maintenance Screen.

The Adjust Brightness/Contrast Screen appears.

Color LCD models

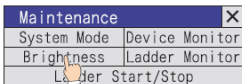

Monochrome LCD models

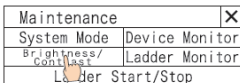

- 2 Press << and >> at the bottom the Adjust Brightness/Contrast Screen to adjust the contrast to the optimal setting.

Color LCD models



Monochrome LCD models

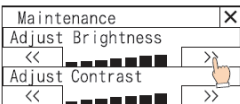

- 3 Press **X** to close the Adjust Brightness/Contrast Screen.

To adjust the brightness and Contrast in the System Mode, use << and >> located at the bottom of the Top Page.

Top Page (Color LCD models)

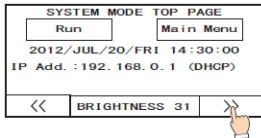

Top Page (Monochrome LCD models)

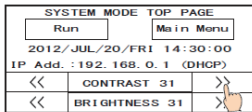

<Note>

Since contrast adjustment is not possible on color LCD models, the contrast adjust function is not displayed.

## 10.4 Adjusting the Touch Panel

A gap may be caused in the operation accuracy of the touch panel by the secular distortion, etc. Adjust the touch panel according to the following procedure when there is a gap in the operation of the touch panel.

- 1 Press **Main Menu** on Top Page in System Mode. The Main Menu appears.

Top Page (Color LCD models)

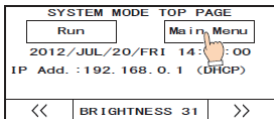

Top Page (Monochrome LCD models)

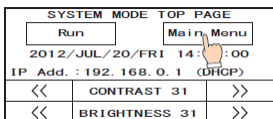

- 2 Press **Init Set, Initialize**, and then **Touch PnlAdj**. The confirmation screen appears and asks "Touch Panel setting?" is displayed. Press **Yes**.  
The Touch Panel Adjust Screen is displayed.
- 3 Press the center of the **X**, then the position of the symbol changes one after another. Press five symbols sequentially.

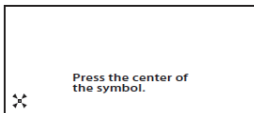

<Note>

When pressing the **X**, make sure to press the center of the symbol. This will ensure the accuracy of the touch panel operation.

- 4 When normally recognized, the confirmation screen of 2 is restored.  
At step 3, when pressing a point away from the center of the **X**, a recognition error will result. Then the **X** returns to the initial position, then repeat the step of 3 again.